



CARACTERÍSTICAS

- Sistema de batente, correr e de vedação.
- Opção de Soldar e de Aparafusar.
- Espessura mínima de 3 mm para soldar;
- Permite utilização de chapas duplas de 20 mm como revestimento, entre outros.

MEDIDAS MÁXIMAS E MÍNIMAS

| Abrir e Pivotante | | | |
|-------------------|--------|--------------|--------|
| Largura Folha | | Altura Folha | |
| Mínimo | Máximo | Mínima | Máxima |
| 600 | 1.600 | 1.000 | 3.000 |

| Correr | | | | | |
|---------------|--------|--------------|--------|-----------|---------|
| Largura Folha | | Altura Folha | | Peso (Kg) | |
| Mínimo | Máximo | Mínima | Máxima | 34991SA | 34992SA |
| 600 | 6.000 | 600 | 2.500 | 800 | 1.200 |

| Vedação | |
|----------------|---------------|
| Largura Máxima | Altura Máxima |
| 6.500 | 2.200 |



| Referência | Secção | Descrição | Stock |
|------------|--------|--|-------|
| A-9201 | | Aro fixo «Soldar» | • |
| A-9202 | | Travessa «Soldar» | • |
| A-9203 | | Folha pequena 80mm «Soldar» | • |
| A-9207 | | Deslizador | • |
| A-9213 | | Folha grande 100mm «Soldar» | • |
| A-9214 | | Guia superior «Soldar» | • |
| A-9258 | | Terminal de correr «Soldar» | • |
| A-9301 | | Aro fixo «Aparafusar» | |
| A-9303 | | Inversor «Aparafusar» | |
| A-9315 | | Guia superior «Aparafusar» | |
| A-9316 | | Capa de remate «Aparafusar» | |
| A-9320 | | Folha superior / Inferior «Aparafusar» | |
| A-9347 | | Travessa «Aparafusar» | |
| A-9358 | | Terminal Correr «Aparafusar» c/5.8m | |
| A-9360 | | Folha lateral «Aparafusar» | |
| A-9364 | | Capa p/folha pivotante «Aparafusar» | |
| A-9365 | | Capa p/aro fixo pivotante «Aparafusar» | |
| A-9366 | | Capa p/folha lateral «Aparafusar» | |
| A-9368 | | Bite redutor cx 3.2mm | |
| A-9369 | | Perfil de remate «Aparafusar» | |
| A-9375 | | Remate p/parede «Aparafusar» | |



| Referência | Secção | Descrição | Stock |
|------------|--------|--------------------------------------|-------|
| A-9401 | | Base p/vedação «Aparafusar» | |
| A-9402 | | Suporte p/vedação «Aparafusar» | |
| A-9403 | | Travessa p/vedação «Aparafusar» | |
| A-9433 | | Lâmina 110mm | |
| A-9434 | | Chapa dupla biselada 200mm | |
| A-9477 | | Suporte lâminas vedação «Aparafusar» | |
| A-024 | | Chapa dupla 20mm | |
| A-124 | | Chapa dupla 100mm | • |
| A-157 | | Para-Sol 120mm | • |
| A-224 | | Chapa dupla 200mm | • |
| A-324 | | Chapa dupla 300mm | |
| 60x60x2,1 | | Tubo 60x60x2,1 | |

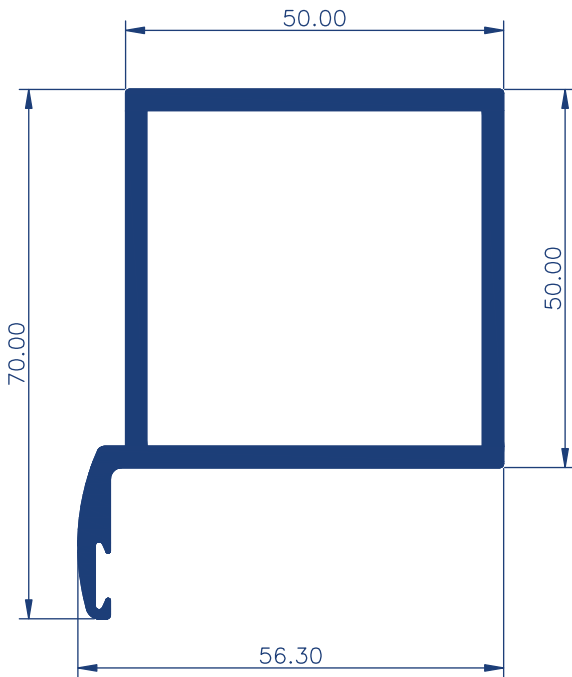

A - 9201

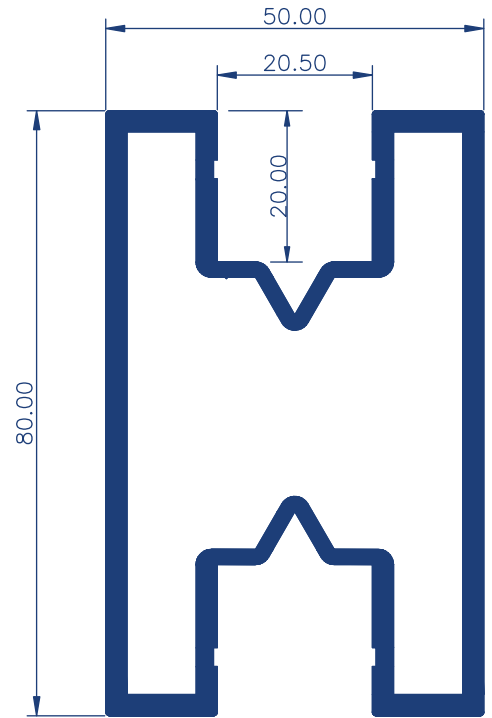

A - 9202

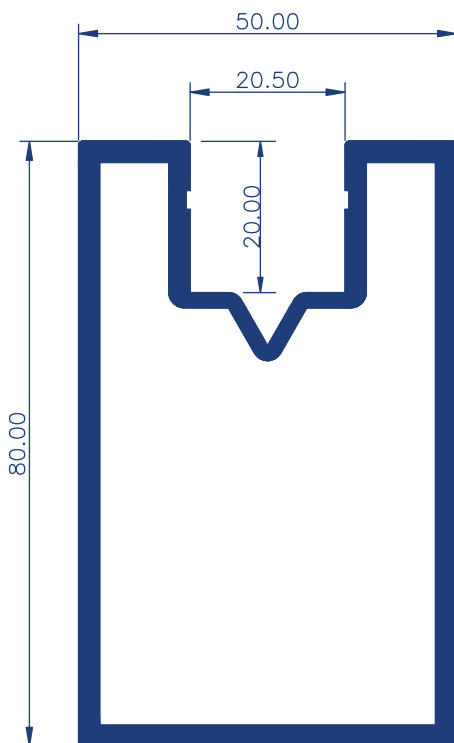

A - 9203

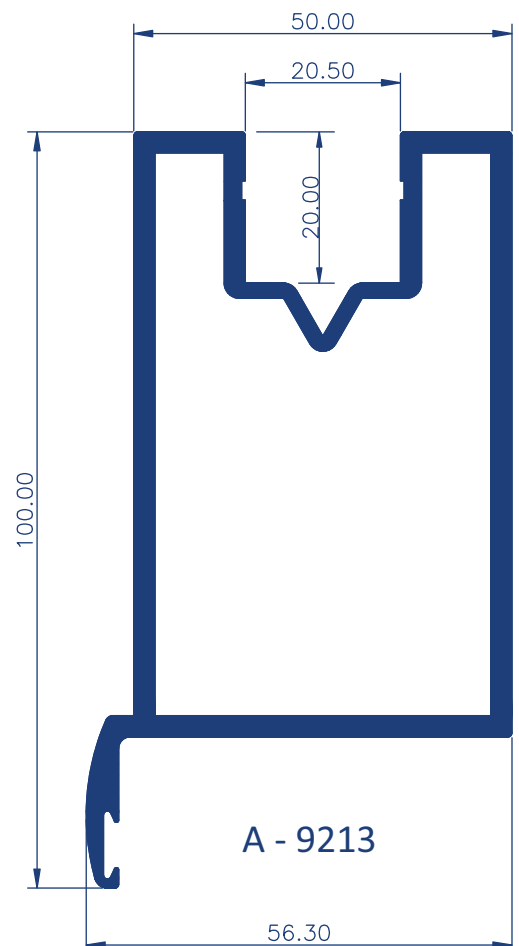

A - 9213

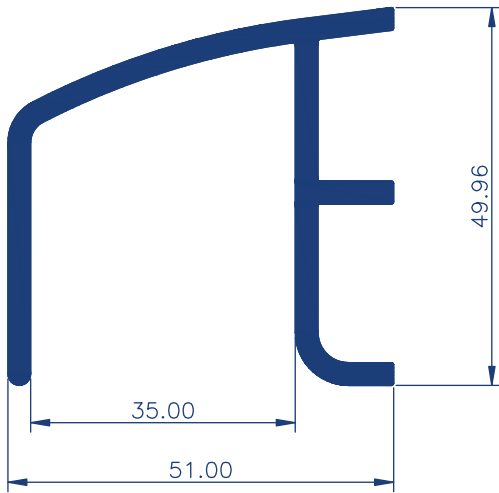

A - 9214

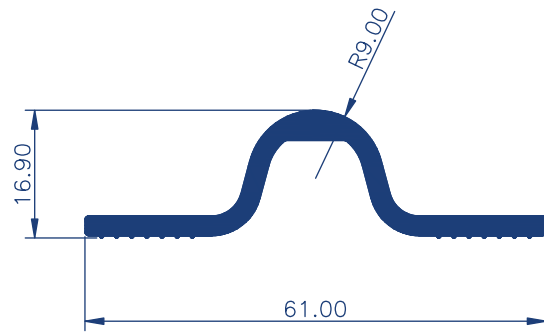

A - 9207

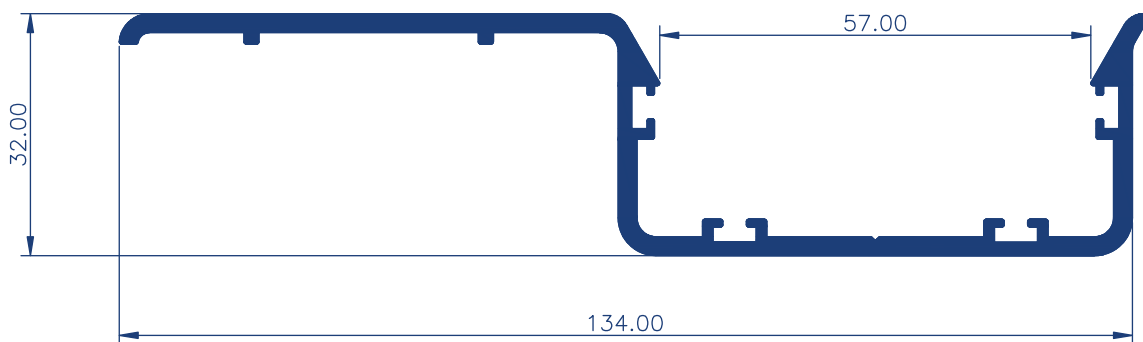

A - 9258

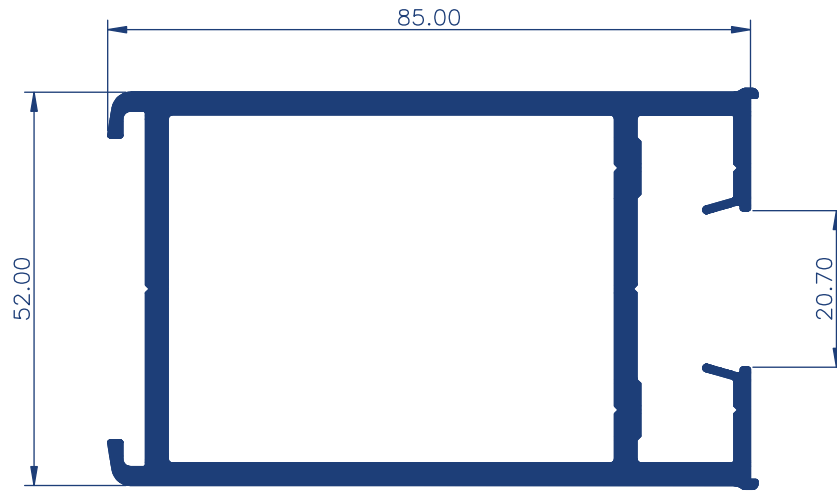

A - 9360

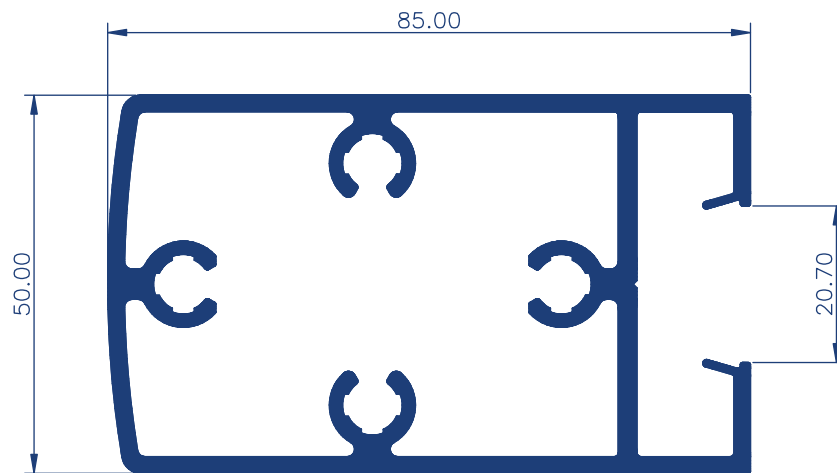

A - 9320

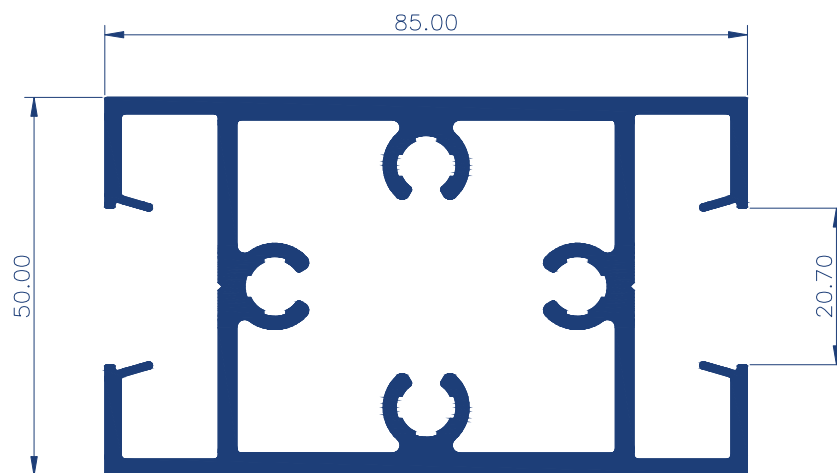

A - 9347

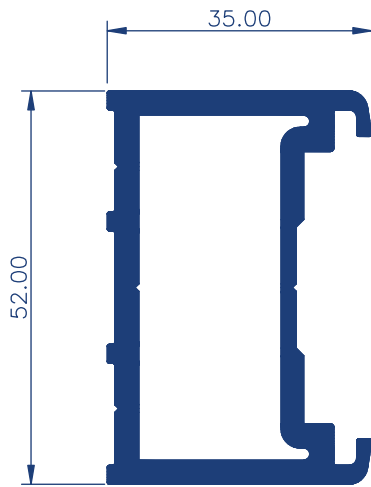

A - 9301

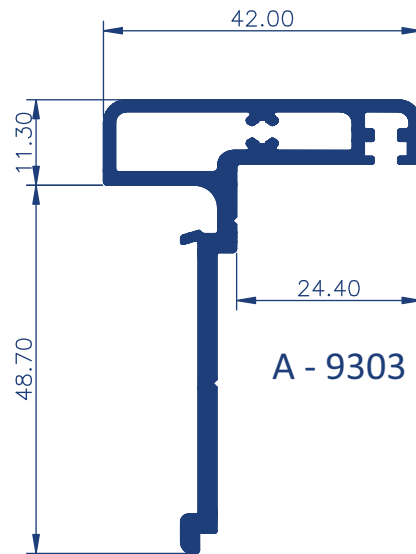

A - 9303



A - 9364

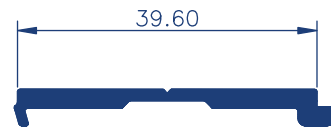

A - 9366



A - 9365

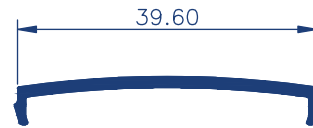

A - 9316

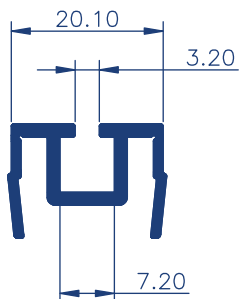

A - 9368

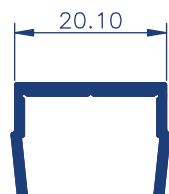

A - 9369

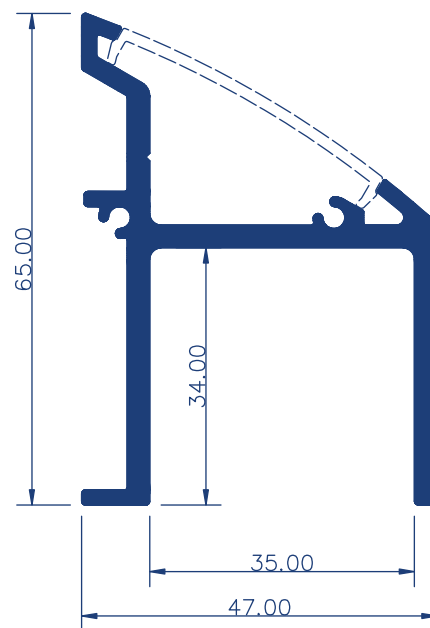

A - 9315

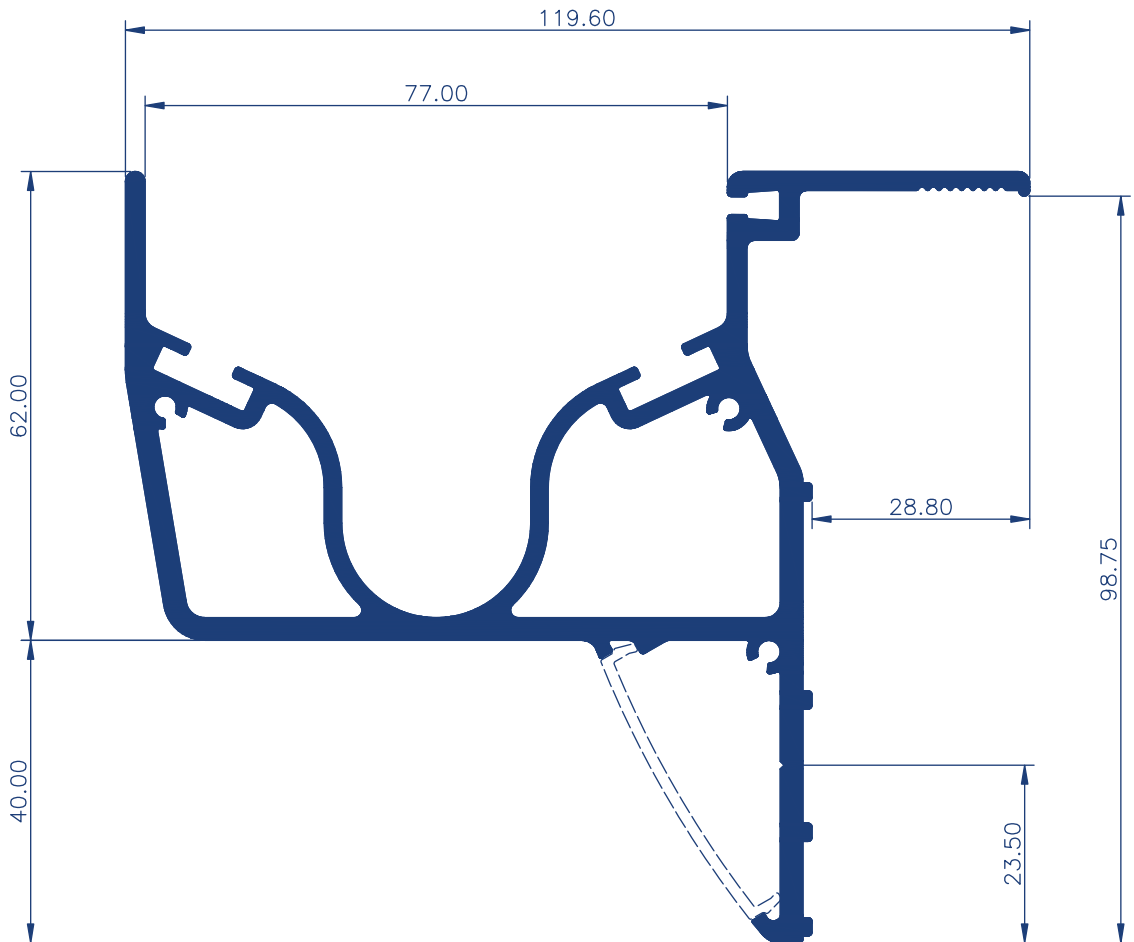

A - 9358

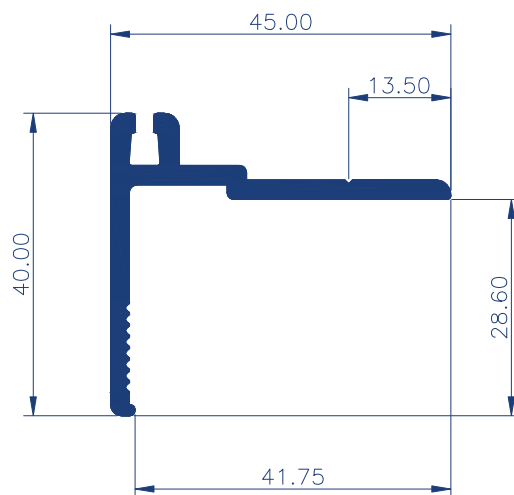

A - 9375

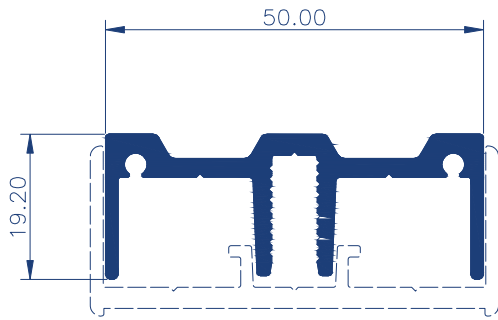

A - 9401

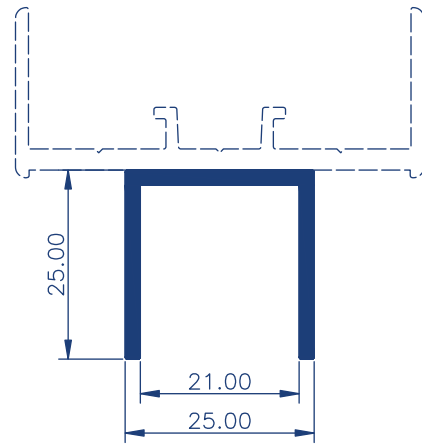

A - 9477

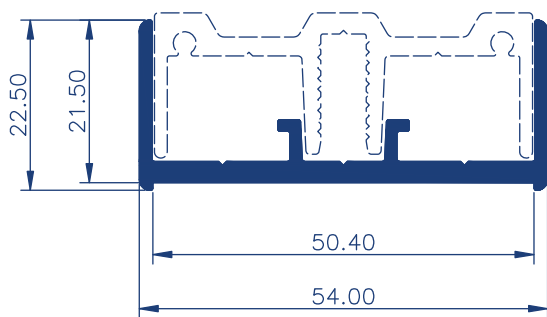

A - 9402

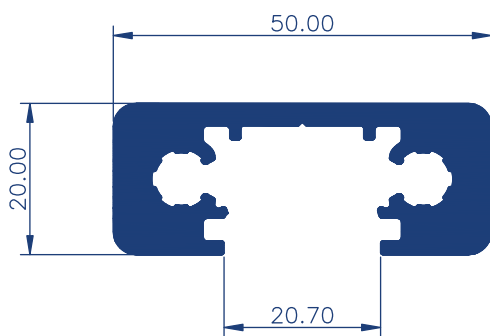

A - 9403

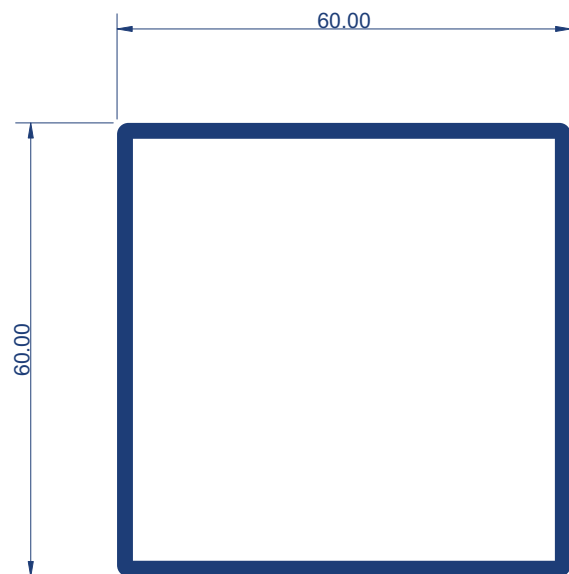

60x60x2,1

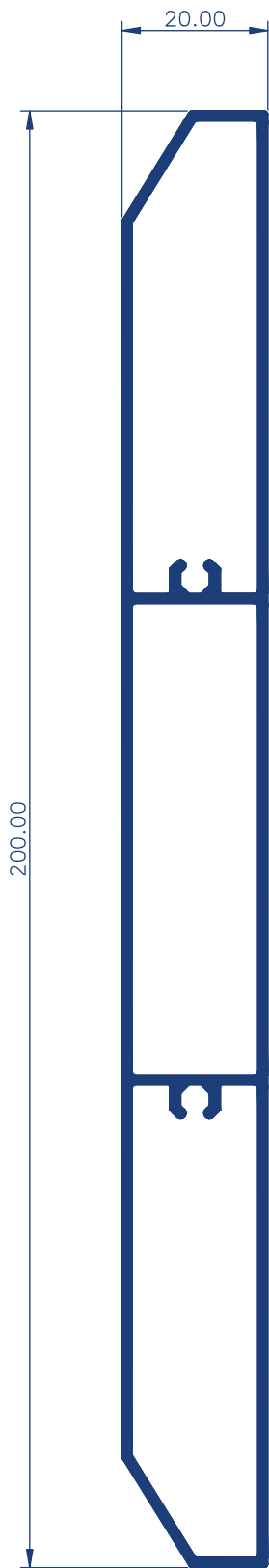

A - 9434

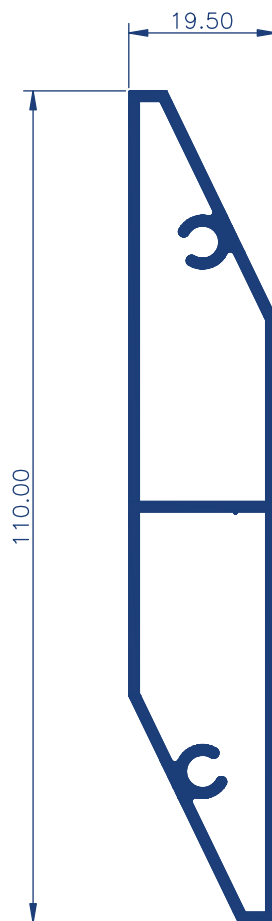



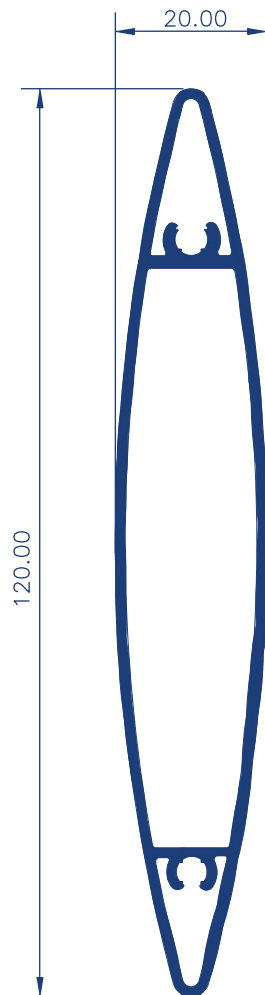







A - 9433



A - 157

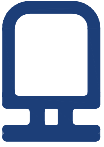











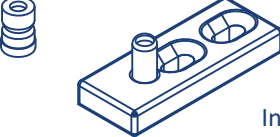
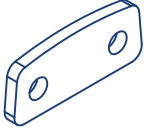
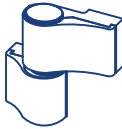

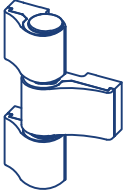
Acessórios (Vedantes)

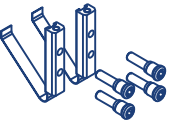
| | |
|--|--|
|  <p>Ref. 30709 Pelúcia 7x7</p> <p>1 m  300 metros</p> | |
|  <p>Ref. 30716 Pelúcia flexível 3.5x19mm</p> <p>1 m  65 metros</p> | |
|  <p>Ref. 30717 Pelúcia flexível 3.5x29mm</p> <p>1 m  65 metros</p> | |
|  <p>Ref. 31098 Vedante de batente (Guia de Portões)</p> <p>1 m  75 metros</p> | |
|  <p>Ref. 31099 Vedante de batente</p> <p>1 m  300 metros</p> | |
| | |

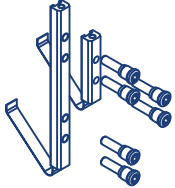

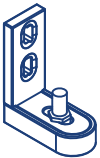



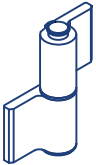
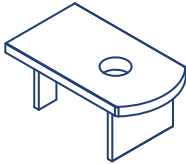

Acessórios (Ferragens)

| | | | |
|--|---|--|---|
|  1 unidade | Ref. 34901SA Calço união folha |  1 unidade | Ref. 34908SA Casquilho de latão para pivô |
|  1 unidade | Ref. 34902SA Parafuso M8x50 |  1 unidade | Ref. 34909** Pivô inferior Inclui casquilho perfurado |
|  1 unidade | Ref. 34903** Suplemento 10mm para 34905 CR/BL/NE/LC/LM |  1 unidade  20 unidades | Ref. 34910** Dobradiça (2 corpos) CR/BL/NE/LC/LC |
|  1 unidade | Ref. 34904** Suplemento 10mm para 34907 CR/BL/NE/LC/LM |  1 unidade  20 unidades | Ref. 34911** Dobradiça (3 corpos) CR/BL/NE/LC/LC |
|  1 unidade | Ref. 34905** Pivô superior CR/BL/NE/LC/LM |  1k't  10 unidades | Ref. 34912SA Kit de fixação para 34910 |
|  1 unidade | Ref. 34906** Pivô inferior CR/BL/NE/LC |  1 kit  10 unidades | Ref. 34913SA Kit de fixação para 34911 |
|  1 unidade | Ref. 34907** Pivô inferior (Alto) CR/BL/NE/LC/LM |  1 kit  1.000 unidades | Ref. 34914SA Parafusos de rosca 60mm |

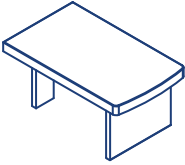
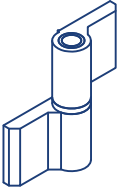
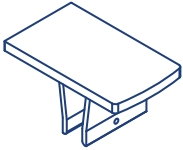
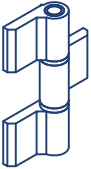
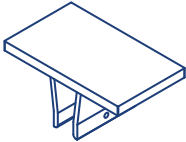
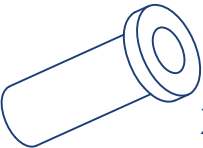

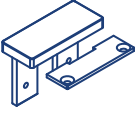

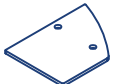

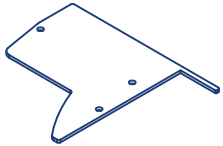
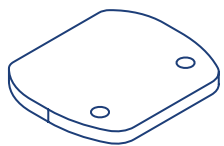

Acessórios (Ferragens)

| | |
|---|---|
|  <p>1 unidade</p> | <p>Ref. 34922** Topo p/folha pivotante BL/NE/CR/LC/LM</p>  <p>1ud</p> |
|  <p>1 unidade</p> | <p>Ref. 34923** Topo p/folha lateral BL/NE/CR/LC/LM</p>  <p>1ud</p> |
|  <p>1 unidade</p> | <p>Ref. 34924** Topo p/folha BL/NE/CR/LC/LM</p>  <p>1ud</p> |
|  <p>1 unidade</p> | <p>Ref. 34925** Topo p/travessa BL/NE/CR/LC/LM</p>  <p>1ud</p> |
|  <p>x3</p> <p>6 unidades</p> | <p>Ref. 34926** Topo p/perfil batente BL/NE/CR/LC/LM</p>  <p>1 jgo</p> |
|  <p>1ud</p> | <p>Ref. 34927** Topo regulável BL/NE/CR/LC/LM</p>  <p>1 jgo</p> |
|  <p>1ud</p> | <p>Ref. 34929** Topo p/guia BL/NE/CR/LC/LM</p>  <p>1ud</p> |

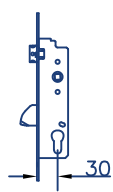
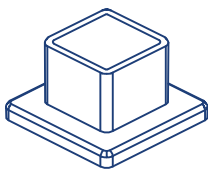
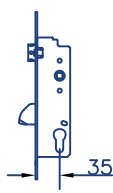
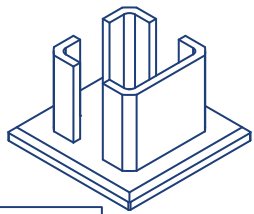
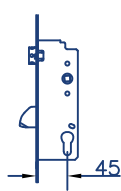
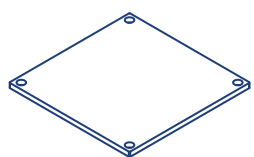

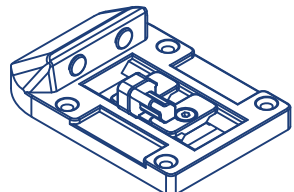
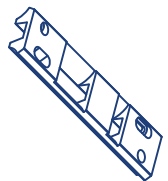
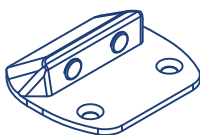







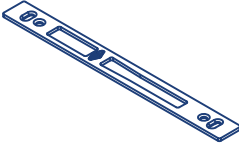
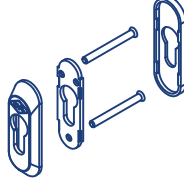
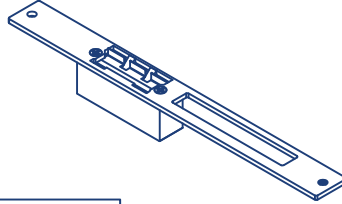

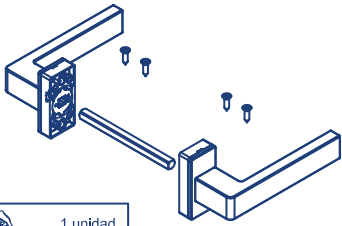
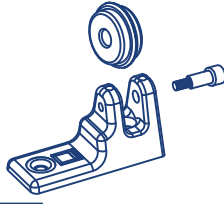
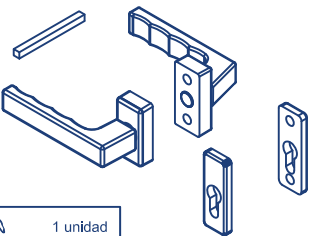
Acessórios (Ferragens)

| | | | |
|--|--|---|---|
|  1ud | Ref. 34930** Topo p/guia superior BL/NE/CR/LC/LM |  1 unidade | Ref. 34942** Suplemento 10mm P/34941 |
|  1kit | Ref. 34931** Topo 60x60 BL/NE/CR/LC/LM |  1 unidade | Ref. 34950SA Fechadura 30mm (55mm) |
|  1kit | Ref. 34932** Base 60x60 BL/NE/CR/LC/LM |  1 unidade | Ref. 34951SA Fechadura 35mm (60mm) |
|  1 unidade | Ref. 34933** Base 80x80 BL/NE/CR/LC/LM |  1 unidade | Ref. 34952SA Fechadura 45mm (60mm) |
|  1 unidade | Ref. 34934** Tampa 80X80 P/1080 BL/NE/CR/LC/LM |  1 unidade | Ref. 34953SA Fechadura 45mm (65mm) - Portão correr |
|  1 unidade | Ref. 34940** Batente central 2 folhas (manual) BL/NE/CR |  1 unidade | Ref. 34955SA Ponto de fecho largo - Portão correr |
|  1 unidade | Ref. 34941** Batente central 2 folhas BL/NE/CR |  1 unidade | Ref. 34956SA Ponto de fecho curto - Portão correr |

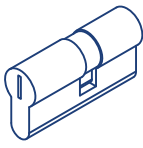

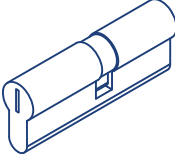



Acessórios (Ferragens)

| | | | |
|---|---|---|---|
|  <p>1 unidade</p> | <p>Ref. 34957SA Chapa de testa portão de batente</p> |  <p>1 unidade</p> | <p>Ref. 32145SA Espelho segurança p/cilindro Preto</p> |
|  <p>1 unidade</p> | <p>Ref. 34958SA Fecho eléctrico portão de batente</p> |  <p>1 unidade</p> | <p>Ref. 32146** Espelho p/cilindro BL/NE/ /LI/LC/SA</p> |
|  <p>1 unidade</p> | <p>Ref. 33320** Puxador duplo BL/LP/NE/LC</p> |  <p>1 unidade</p> | <p>Ref. 34970** Guia portão correr CR/BL/NE/LC</p> |
|  <p>1 unidade</p> | <p>Ref. 34007A** Kit puxador duplo Toulon c/roseta e espelho</p> |  <p>1 unidade</p> | <p>Ref. 34971SA Batente 120X30 Zincado</p> |
|  <p>x2 1 unidade</p> | <p>Ref. 34009SA Expansor Quadra 8X75 P/34007A</p> |  <p>1 unidade</p> | <p>Ref. 34972SA Batente 120X30 Inox</p> |
|  <p>x ud</p> | <p>Ref. 32149SA Cilindro 60mm (30-30)</p> |  <p>1 unidade</p> | <p>Ref. 34980SA Rolamento de guia 25mm</p> |
|  <p>x ud</p> | <p>Ref. 32119SA Cilindro 70mm (35-35)</p> |  <p>1 unidade</p> | <p>Ref. 34981SA Rolamento de guia 33.5mm</p> |

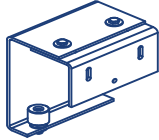
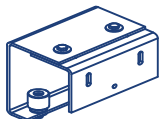
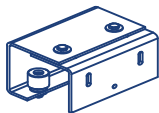
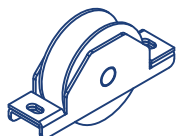

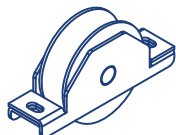
Acessórios (Ferragens)

| | | |
|--|---|--|
|  1 unidade | <p>Ref. 34985**</p> <p>Suporte guia superior - grande 170x120x40</p> <p>Rolamento não incluído</p> | |
|  1 unidade | <p>Ref. 34986**</p> <p>Suporte guia superior - média 170x100x40</p> <p>Rolamento não incluído</p> | |
|  1 unidade | <p>Ref. 34987**</p> <p>Suporte guia superior - pequeno 170x80x40</p> <p>Rolamento não incluído</p> | |
|  1 unidade  10 unidades | <p>Ref. 34991SA</p> <p>Rodízio nylon 80mm ZINCADO (800Kg)</p> | |
|  1 unidade  10 unidades | <p>Ref. 34992SA</p> <p>Rodízio nylon 80mm INOX (1200Kg)</p> | |
| <p>LEGENDA DE ACABAMENTOS</p> <p>SA: Sem acabamento BL: Lacado a Branco NE: Lacado a Preto LP: Lacado a Prata LC: Lacado à Cor LM: Lacado a Madeira CR: Bruto</p> | | |

Portão de 1 Folha (Aparafusar)

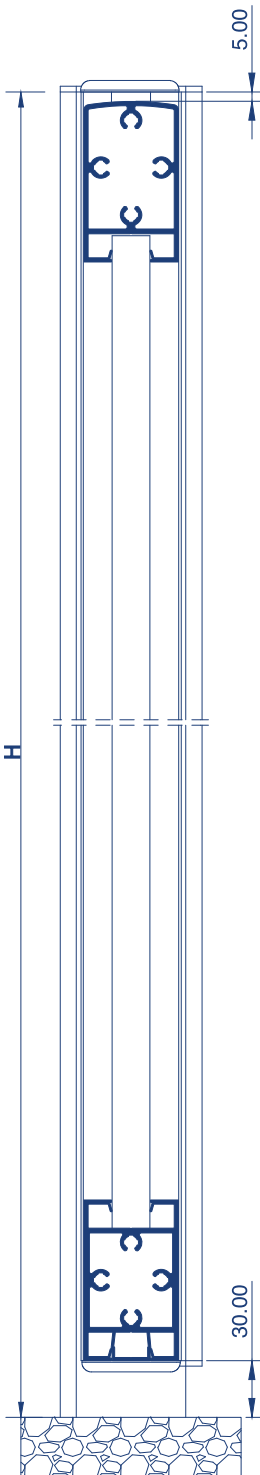
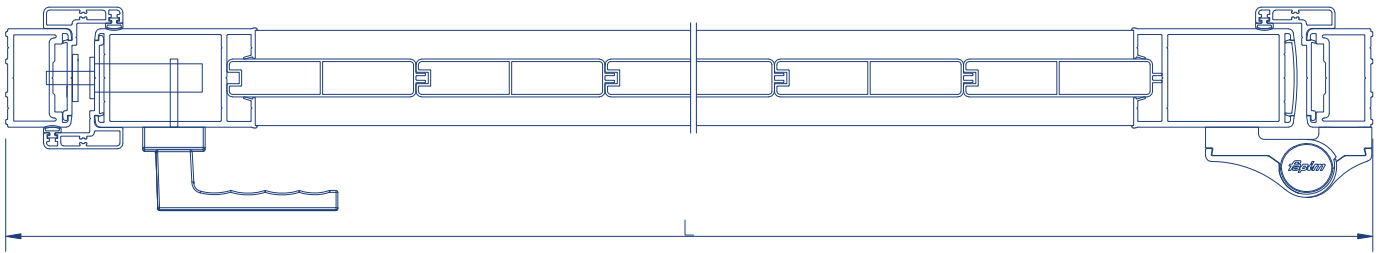

| | Ref. | Descrição | Horizontal | | | Vertical | | |
|--|--------|-------------------|------------|-----|--------|----------|--------------|-----------|
| | | | Corte | Qt. | Medida | Corte | Qt. | Medida |
| | A-9301 | Aro fixo | | | | | 2 | H |
| | A-9303 | Inversor | | | | | 2 1 | H H-30 |
| | A-9360 | Folha lateral | | | | | 2 | H-30 |
| | A-9316 | Capa de remate | | | | | 1 | H-30 |
| | A-9320 | Folha sup./inf. | | 1 | L-259 | | | |
| | A-9347 | Travessa | | 1 | L-259 | | | |
| | A-9369 | Perfil remate | | 1 | L-259 | | 2 | 10 |
| | A-124 | Chapa dupla 100mm | | | | | L-229 100 | H-175 |

| Ref. | Descrição | Vertical | |
|-------|--------------------|----------|--------|
| | | Qt. | Medida |
| 31099 | Vedante de batente | 3 | H |

| Ref. | Descrição | Qt. | Consultar Tabela |
|-------|-----------------------------------|-----|------------------|
| 34921 | Topo p/arco fixo | 2 | |
| 34923 | Topo p/folha lateral | 4 | |
| 34926 | Topo p/perfil de batente | 2 | |
| 34901 | Calço união folha | 4 | |
| 34910 | Dobradiça (2 corpos) | 2 | |
| 34911 | Dobradiça (3 corpos) | 2 | |
| 34912 | Kit de fixação p/34910 | 2 | |
| 34913 | Kit de fixação p/34911 | 2 | |
| 34952 | Fechadura 45mm | 1 | |
| 32119 | Cilindro 70mm | 1 | |
| 34957 | Chapa de testa p/portão batente | 1 | |
| 34958 | Fecho eléctrico p/portão batente | 1 | |
| 34902 | Parafuso M8x50 | 16 | |
| 34007 | Kit puxador duplo Toulon c/roseta | 1 | |





Portão de 1 Folha C/Travessa (Aparafusar)

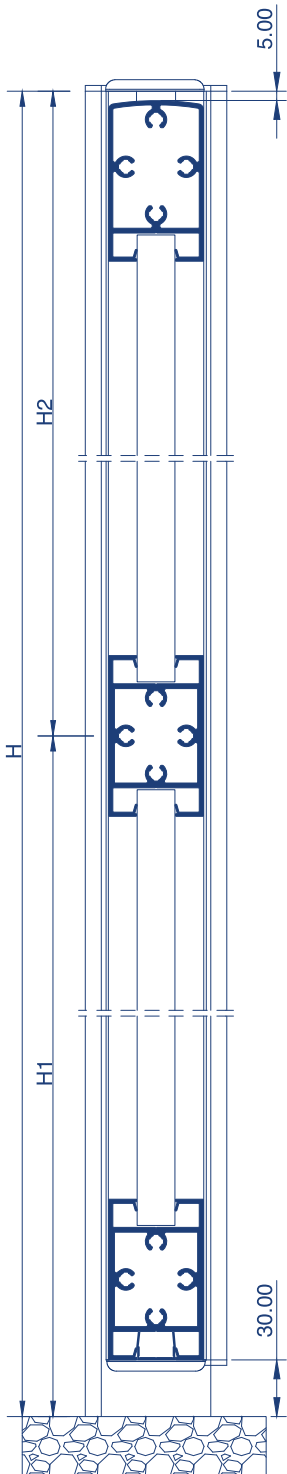
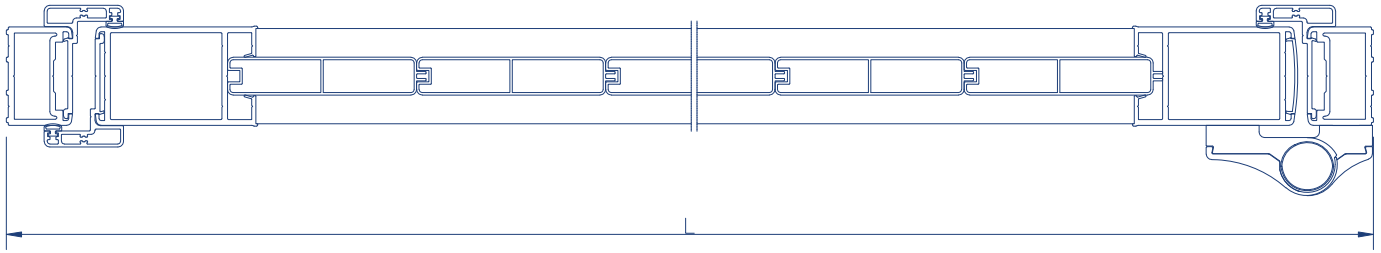

| | Ref. | Descrição | Horizontal | | | Vertical | | |
|--|--------|-------------------|------------|-----|--------|----------|------------------------------|------------------|
| | | | Corte | Qt. | Medida | Corte | Qt. | Medida |
| | A-9301 | Aro fixo | | 2 | H | | | |
| | A-9303 | Inversor | | 2 | H | | 1 | H-30 |
| | A-9360 | Folha lateral | | 2 | H-30 | | | |
| | A-9316 | Capa de remate | | 1 | H-30 | | | |
| | A-9320 | Folha sup./inf. | | 1 | L-259 | | | |
| | A-9347 | Travessa | | 2 | L-259 | | | |
| | A-9369 | Perfil remate | | 1 | L-259 | | 2 | 10 |
| | A-124 | Chapa dupla 100mm | | | | | L-229 100 L-229 100 | H1-128 H2-103 |

| Ref. | Descrição | Vertical | |
|-------|--------------------|----------|--------|
| | | Qt. | Medida |
| 31099 | Vedante de batente | 3 | H |

| Ref. | Descrição | Qt. |
|-------|--------------------------|-----|
| 34921 | Topo p/aro fixo | 2 |
| 34923 | Topo p/folha lateral | 4 |
| 34926 | Topo p/perfil de batente | 2 |
| 34901 | Calço união folha | 6 |
| 34910 | Dobradiça (2 corpos) | 2 |
| 34911 | Dobradiça (3 corpos) | 2 |
| 34912 | Kit de fixação p/34910 | 2 |
| 34913 | Kit de fixação p/34911 | 2 |
| 34902 | Parafuso M8x50 | 24 |

Consultar Tabela

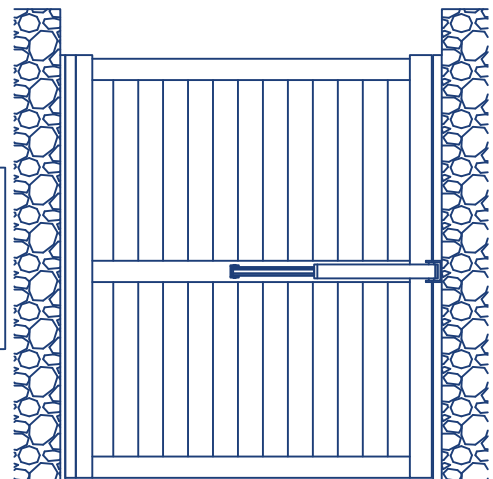

Portão de 2 Folhas (Aparafusar)

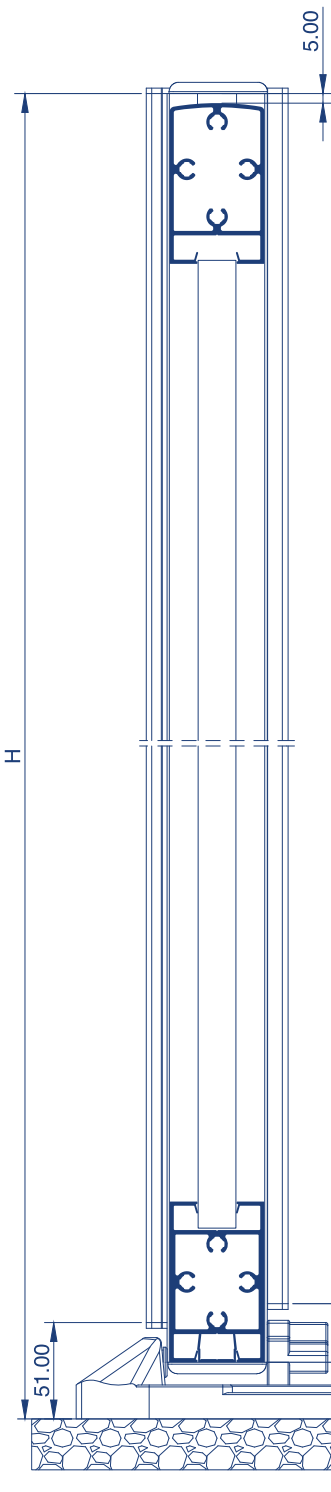
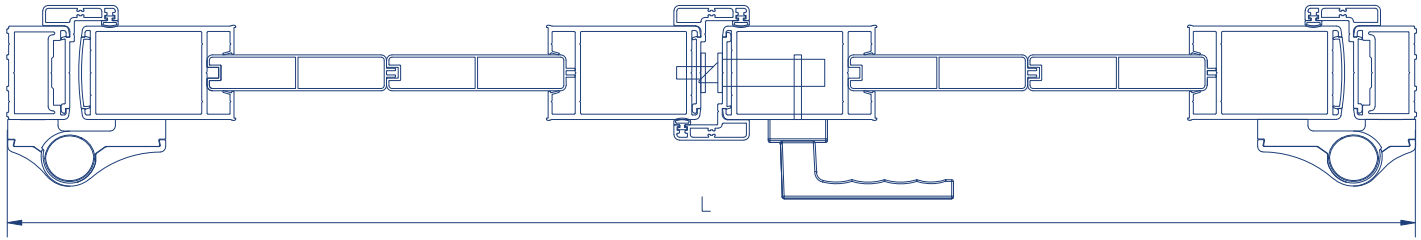

| | Ref. | Descrição | Horizontal | | | Vertical | | |
|--|--------|-------------------|------------|-----|---------|----------|---|--------|
| | | | Corte | Qt. | Medida | Corte | Qt. | Medida |
| | A-9301 | Aro fixo | | 2 | | | | H |
| | A-9303 | Inversor | | 2 | | | | H |
| | A-9360 | Folha lateral | | 1 | | | | H-51 |
| | A-9360 | Folha lateral | | 1 | | | | H-61 |
| | A-9360 | Folha lateral | | 4 | | | | H-30 |
| | A-9316 | Capa de remate | | 2 | | | | H-30 |
| | A-9320 | Folha sup./inf. | | 2 | L/2-218 | | | |
| | A-9347 | Travessa | | 2 | L/2-218 | | | |
| | A-9369 | Perfil remate | | 2 | L/2-218 | | 4 | 10 |
| | A-124 | Chapa dupla 100mm | | | | | $\left[\frac{L/2-188}{100} \right] \times 2$ | H-175 |

| Ref. | Descrição | Vertical | |
|-------|--------------------|----------|--------|
| | | Qt. | Medida |
| 31099 | Vedante de batente | 4 | H |

| Ref. | Descrição | Qt. | |
|------------------|--------------------------|-----------------------------------|----|
| 34921 | Topo p/aro fixo | 2 | |
| 34923 | Topo p/folha lateral | 8 | |
| 34926 | Topo p/perfil de batente | 3 | |
| 34901 | Calço união folha | 8 | |
| Consultar Tabela | 34910 | Dobradiça (2 corpos) | 4 |
| | 34911 | Dobradiça (3 corpos) | |
| | 34912 | Kit de fixação p/34910 | 4 |
| | 34913 | Kit de fixação p/34911 | |
| | 34952 | Fechadura 45mm | 1 |
| | 32119 | Cilindro 70mm | 1 |
| | 34957 | Chapa de testa p/portão batente | 1 |
| | 34958 | Fecho eléctrico p/portão batente | |
| | 34902 | Parafuso M8x50 | 32 |
| | 34007 | Kit puxador duplo Toulon c/roseta | 1 |
| | 34940 | Batente central 2 folhas | 1 |

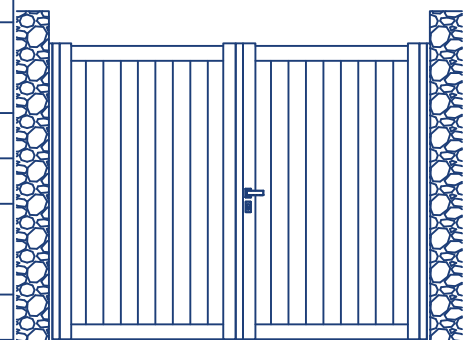



Portão de 2 Folhas C/Travessa (Aparafusar)

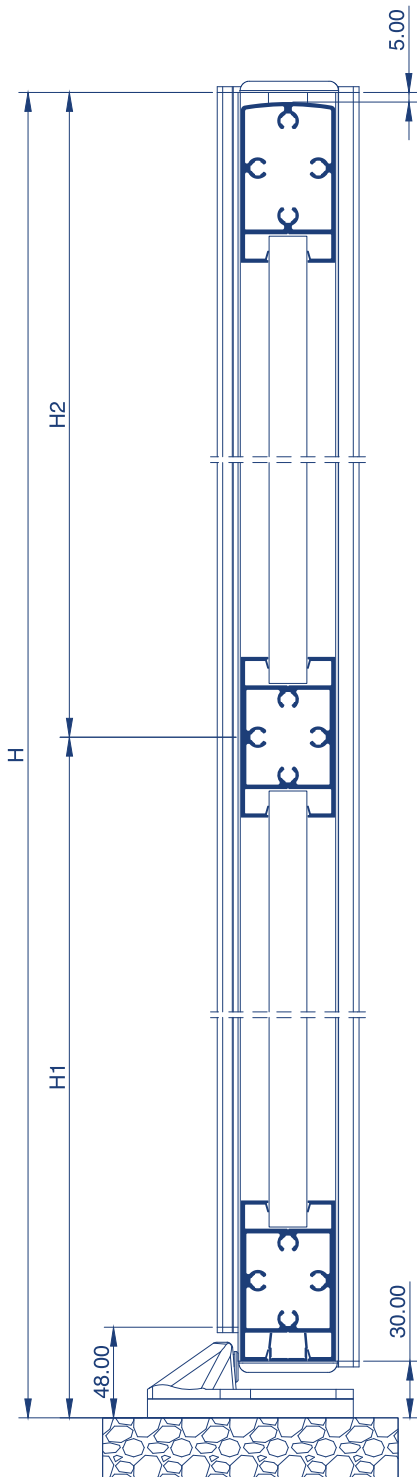
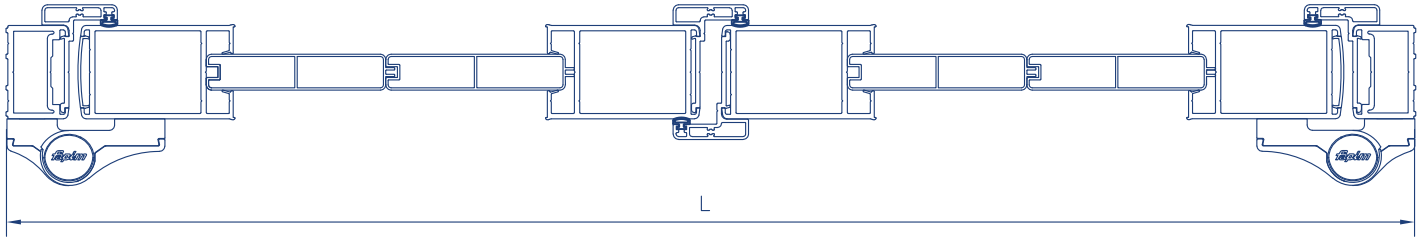

| | Ref. | Descrição | Horizontal | | | Vertical | | |
|--|--------|-------------------|------------|-----|---------|----------|---|--|
| | | | Corte | Qt. | Medida | Corte | Qt. | Medida |
| | A-9301 | Aro fixo | | | | | 2 | H |
| | A-9303 | Inversor | | | | | 2 | H |
| | A-9360 | Folha lateral | | | | | 4 | H-30 |
| | A-9316 | Capa de remate | | | | | 2 | H-30 |
| | A-9320 | Folha sup./inf. | | 2 | L/2-218 | | | |
| | A-9347 | Travessa | | 4 | L/2-218 | | | |
| | A-9369 | Perfil remate | | 2 | L/2-218 | | 4 | 10 |
| | A-124 | Chapa dupla 100mm | | | | | $\begin{matrix} L/2-188 \\ 100 \\ L/2-188 \\ 100 \end{matrix} \times 2$ | $\begin{matrix} H1-128 \\ H2-103 \end{matrix}$ |

| Ref. | Descrição | Vertical | |
|-------|--------------------|----------|--------|
| | | Qt. | Medida |
| 31099 | Vedante de batente | 4 | H |

| Ref. | Descrição | Qt. |
|-------|--------------------------|-----|
| 34921 | Topo p/aro fixo | 2 |
| 34923 | Topo p/folha lateral | 8 |
| 34926 | Topo p/perfil de batente | 3 |
| 34901 | Calço união folha | 12 |
| 34910 | Dobradiça (2 corpos) | 4 |
| 34911 | Dobradiça (3 corpos) | |
| 34912 | Kit de fixação p/34910 | 4 |
| 34913 | Kit de fixação p/34911 | |
| 34902 | Parafuso M8x50 | 48 |
| 34941 | Batente central 2 folhas | 1 |
| 34942 | Suplemento p/ 34941 | 1 |

Consultar Tabela

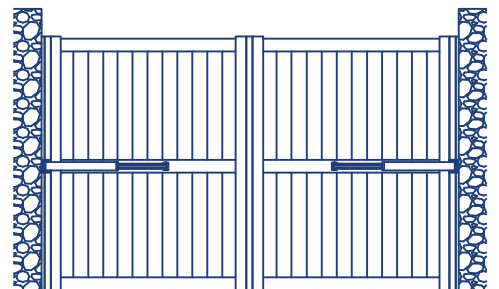

Portão Pivotante de 1 Folha (Aparafusar)

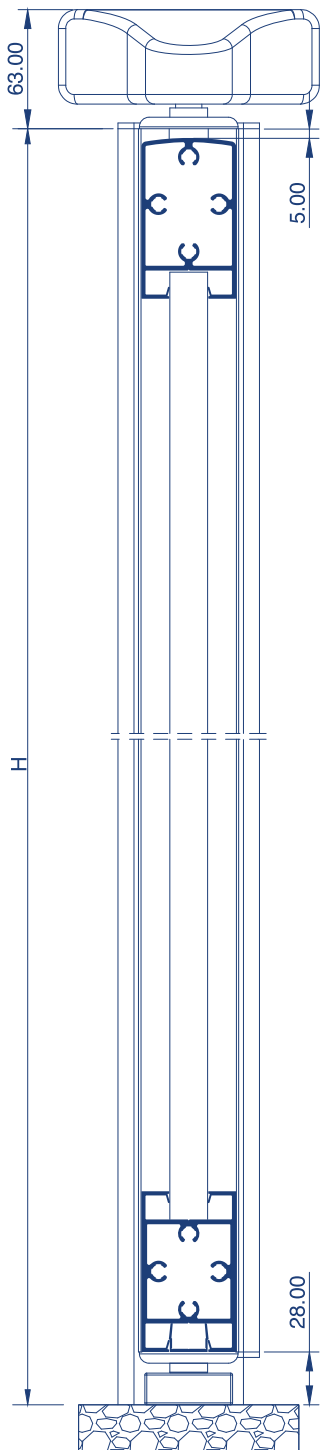
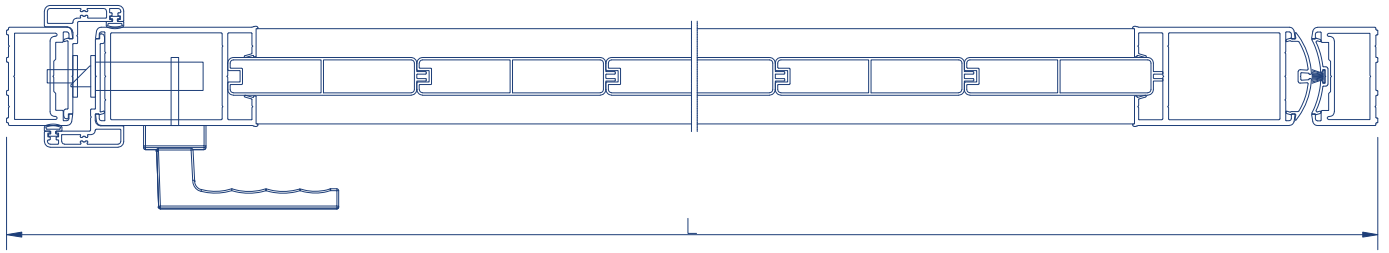

| | Ref. | Descrição | Horizontal | | | Vertical | | |
|--|--------|---------------------------|------------|-----|--------|----------|---------------------|--------|
| | | | Corte | Qt. | Medida | Corte | Qt. | Medida |
| | A-9301 | Aro fixo | | | | | 2 | H |
| | A-9303 | Inversor | | | | | 1 | H |
| | A-9360 | Folha lateral | | | | | 2 | H-28 |
| | A-9364 | Capa p/folha pivotante | | | | | 1 | H-28 |
| | A-9365 | Capa p/aro fixo pivotante | | | | | 1 | H |
| | A-9320 | Folha sup./inf. | | 1 | L-261 | | | |
| | A-9347 | Travessa | | 1 | L-261 | | | |
| | A-9369 | Perfil remate | | 1 | L-261 | | 2 | 10 |
| | A-124 | Chapa dupla 100mm | | | | | $\frac{L-231}{100}$ | H-173 |

| Ref. | Descrição | Qt. |
|-------|-----------------------------------|-----|
| 34921 | Topo p/aro fixo | 1 |
| 34920 | Topo p/aro fixo pivotante | 1 |
| 34922 | Topo p/folha pivotante | 2 |
| 34923 | Topo p/folha lateral | 2 |
| 34926 | Topo p/perfil de batente | 2 |
| 34901 | Calço união folha | 4 |
| 34905 | Pivô superior | 1 |
| 34906 | Pivô inferior | 1 |
| 34908 | Casquilho de latão para pivô | 2 |
| 34952 | Fechadura 45mm | 1 |
| 32119 | Cilindro 70mm | 1 |
| 34957 | Chapa de testa p/portão batente | 1 |
| 34958 | Fecho eléctrico p/portão batente | 1 |
| 34902 | Parafuso M8x50 | 16 |
| 34007 | Kit puxador duplo Toulon c/roseta | 1 |

| Ref. | Descrição | Vertical | |
|-------|--------------------|----------|--------|
| | | Qt. | Medida |
| 31099 | Vedante de batente | 2 | H |
| 30709 | Pelúcia 7x7 | 1 | H |

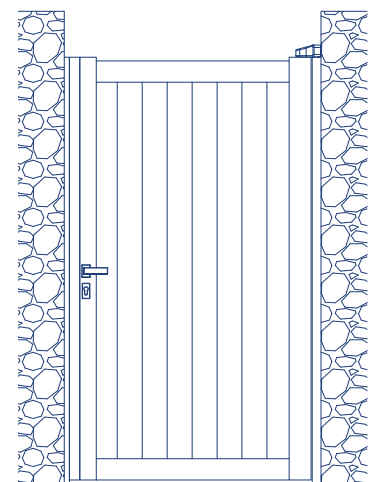



Portão Pivotante de 1 Folha C/Travessa (Aparafusar)

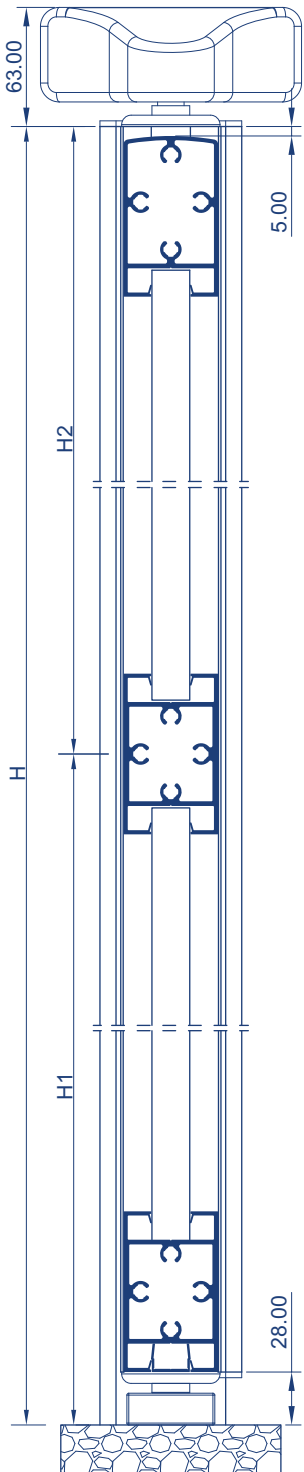
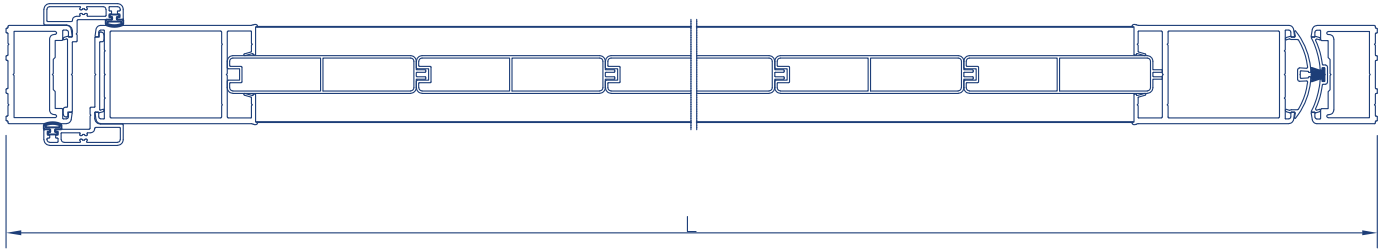

| | Ref. | Descrição | Horizontal | | | Vertical | | |
|--|--------|---------------------------|------------|-----|--------|----------|--|------------------|
| | | | Corte | Qt. | Medida | Corte | Qt. | Medida |
| | A-9301 | Aro fixo | | | | | 2 | H |
| | A-9303 | Inversor | | | | | 1 | H |
| | A-9360 | Folha lateral | | | | | 1 | H-28 |
| | A-9364 | Capa p/folha pivotante | | | | | 2 | H-28 |
| | A-9365 | Capa p/aro fixo pivotante | | | | | 1 | H |
| | A-9320 | Folha sup./inf. | | 1 | L-261 | | | |
| | A-9347 | Travessa | | 2 | L-261 | | | |
| | A-9369 | Perfil remate | | 1 | L-261 | | 2 | 20 |
| | A-124 | Chapa dupla 100mm | | | | | $\frac{L-231}{100}$ $\frac{L-231}{100}$ | H1-126 H2-113 |

| Ref. | Descrição | Qt. |
|-------|------------------------------|-----|
| 34921 | Topo p/aro fixo | 1 |
| 34920 | Topo p/aro fixo pivotante | 1 |
| 34922 | Topo p/folha pivotante | 2 |
| 34923 | Topo p/folha lateral | 2 |
| 34926 | Topo p/perfil de batente | 2 |
| 34901 | Calço união folha | 6 |
| 34905 | Pivô superior | 1 |
| 34906 | Pivô inferior | 1 |
| 34908 | Casquilho de latão para pivô | 2 |
| 34902 | Parafuso M8x50 | 24 |

| Ref. | Descrição | Vertical | |
|-------|--------------------|----------|--------|
| | | Qt. | Medida |
| 31099 | Vedante de batente | 2 | H |
| 30709 | Pelúcia 7x7 | 1 | H |

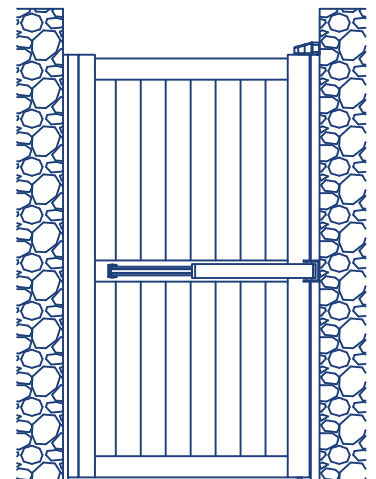

Portão Pivotante de 2 Folhas (Aparafusar)

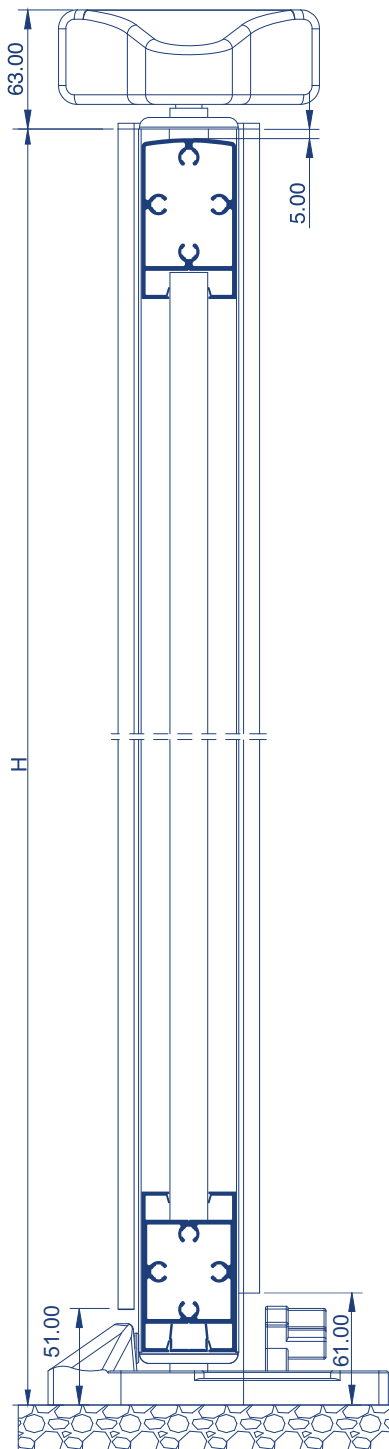
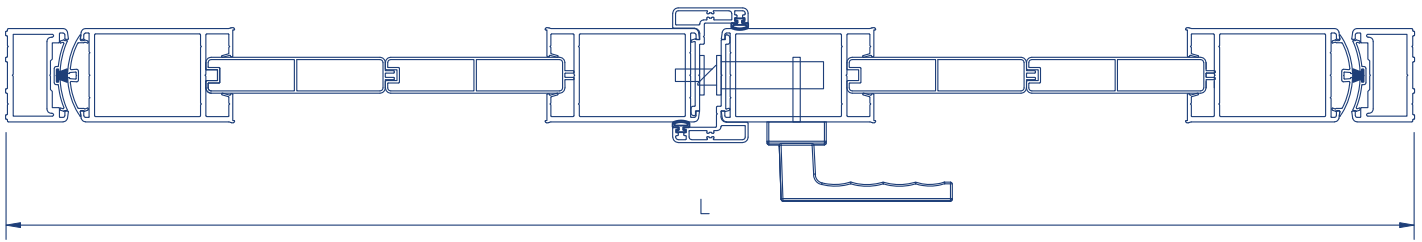

| | Ref. | Descrição | Horizontal | | | Vertical | | |
|--|--------|---------------------------|------------|-----|---------|----------|---|--------------|
| | | | Corte | Qt. | Medida | Corte | Qt. | Medida |
| | A-9301 | Aro fixo | | 2 | | | | H |
| | A-9303 | Inversor | | 1 | | | 1 | H-51 H-61 |
| | A-9360 | Folha lateral | | 4 | | | | H-28 |
| | A-9364 | Capa p/folha pivotante | | 2 | | | | H-28 |
| | A-9365 | Capa p/aro fixo pivotante | | 2 | | | | H |
| | A-9320 | Folha sup./inf. | | 2 | L/2-220 | | | |
| | A-9347 | Travessa | | 2 | L/2-220 | | | |
| | A-9369 | Perfil remate | | 2 | L/2-220 | | 4 | 10 |
| | A-124 | Chapa dupla 100mm | | | | | $\left[\frac{L/2-190}{100} \right] \times 2$ | H-173 |

| Ref. | Descrição | Qt. |
|-------|-----------------------------------|-----|
| 34920 | Topo p/aro fixo pivotante | 2 |
| 34922 | Topo p/folha pivotante | 4 |
| 34923 | Topo p/folha lateral | 4 |
| 34926 | Topo p/perfil de batente | 2 |
| 34901 | Calço união folha | 8 |
| 34905 | Pivô superior | 2 |
| 34906 | Pivô inferior | 2 |
| 34908 | Casquilho de latão para pivô | 4 |
| 34940 | Batente central 2 folhas | 1 |
| 34952 | Fechadura 45mm | 1 |
| 32119 | Cilindro 70mm | 1 |
| 34957 | Chapa de testa p/portão batente | 1 |
| 34902 | Parafuso M8x50 | 32 |
| 34007 | Kit puxador duplo Toulon c/roseta | 1 |

| Ref. | Descrição | Vertical | |
|-------|--------------------|----------|--------|
| | | Qt. | Medida |
| 31099 | Vedante de batente | 2 | H |
| 30709 | Pelúcia 7x7 | 2 | H |

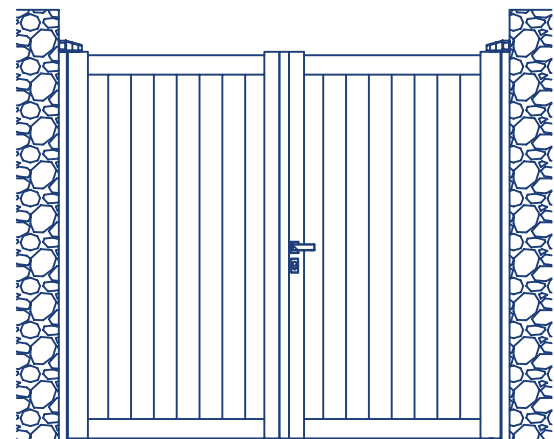



Portão Pivotante de 2 Folhas C/Travessa (Aparafusar)

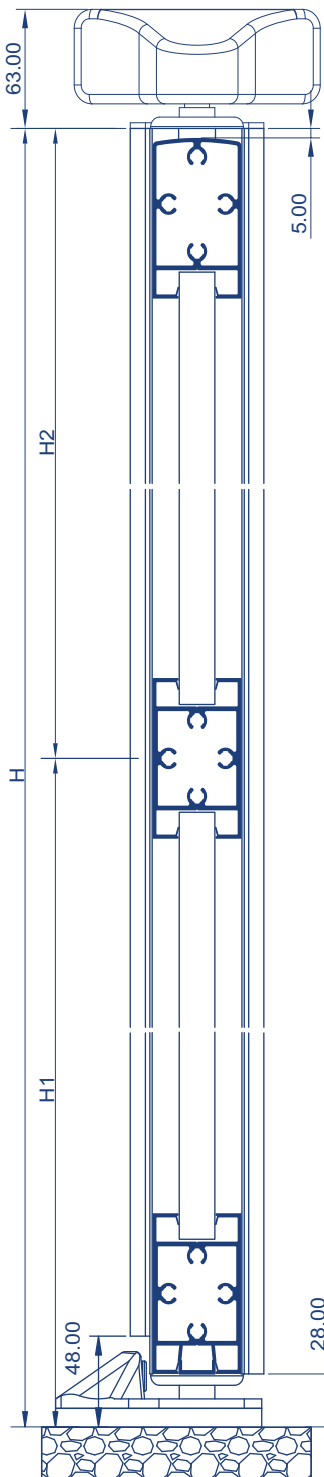
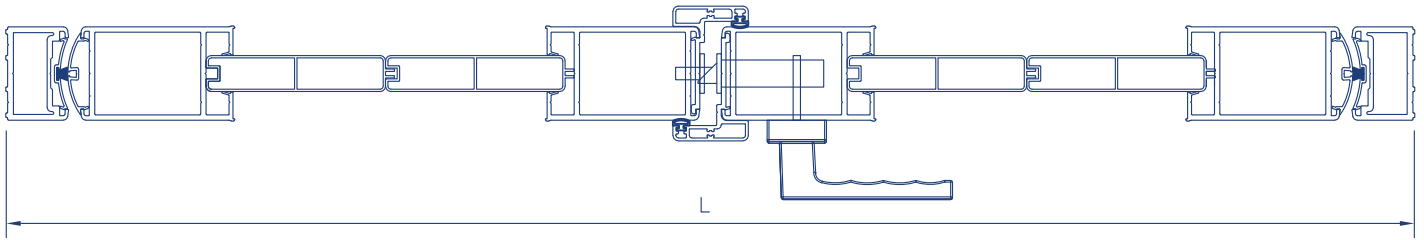

| | Ref. | Descrição | Horizontal | | | Vertical | | |
|--|--------|---------------------------|------------|-----|---------|----------|--------------------------------|------------------|
| | | | Corte | Qt. | Medida | Corte | Qt. | Medida |
| | A-9301 | Aro fixo | | 2 | H | | | |
| | A-9303 | Inversor | | 1 | H-28 | | 1 | H-48 |
| | A-9360 | Folha lateral | | 4 | H-28 | | | |
| | A-9364 | Capa p/folha pivotante | | 2 | H-28 | | | |
| | A-9365 | Capa p/aro fixo pivotante | | 2 | H | | | |
| | A-9320 | Folha sup./inf. | | 2 | L/2-220 | | | |
| | A-9347 | Travessa | | 4 | L/2-220 | | | |
| | A-9369 | Perfil remate | | 2 | L/2-220 | | 4 | 10 |
| | A-124 | Chapa dupla 100mm | | | | | $\frac{L/2-190}{100} \times 2$ | H1-126 H2-103 |

| Ref. | Descrição | Vertical | |
|-------|--------------------|----------|--------|
| | | Qt. | Medida |
| 31099 | Vedante de batente | 2 | H |
| 30709 | Pelúcia 7x7 | 2 | H |

| Ref. | Descrição | Qt. |
|-------|------------------------------|-----|
| 34920 | Topo p/aro fixo pivotante | 2 |
| 34922 | Topo p/folha pivotante | 4 |
| 34923 | Topo p/folha lateral | 4 |
| 34926 | Topo p/perfil de batente | 2 |
| 34901 | Calço união folha | 12 |
| 34905 | Pivô superior | 2 |
| 34906 | Pivô inferior | 2 |
| 34908 | Casquilho de latão para pivô | 4 |
| 34941 | Batente central 2 folhas | 1 |
| 34942 | Suplemento p/ 34941 | 1 |
| 34902 | Parafuso M8x50 | 48 |

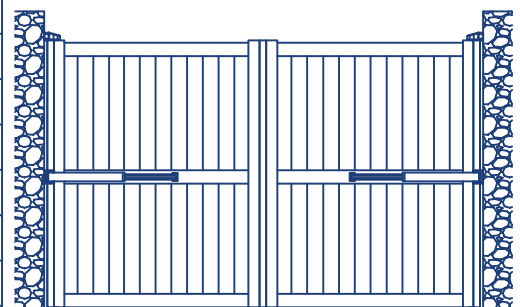

Portão de Correr (Aparafusar)

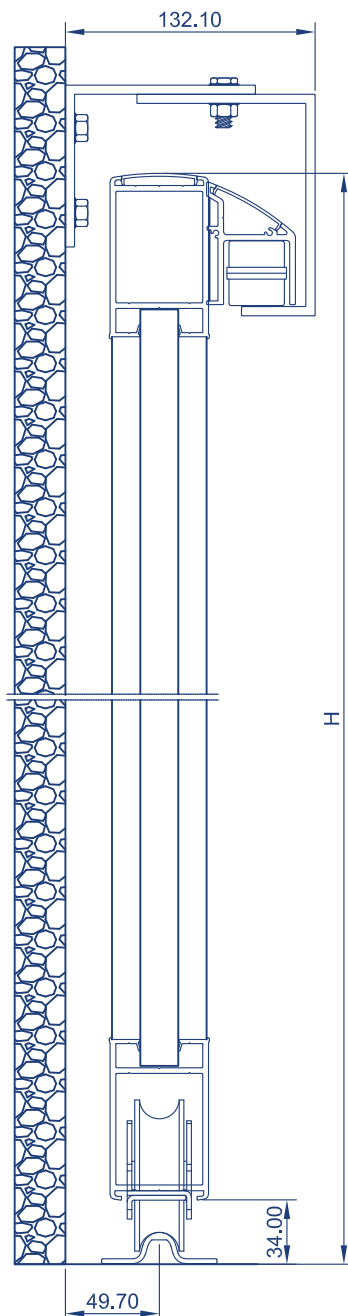
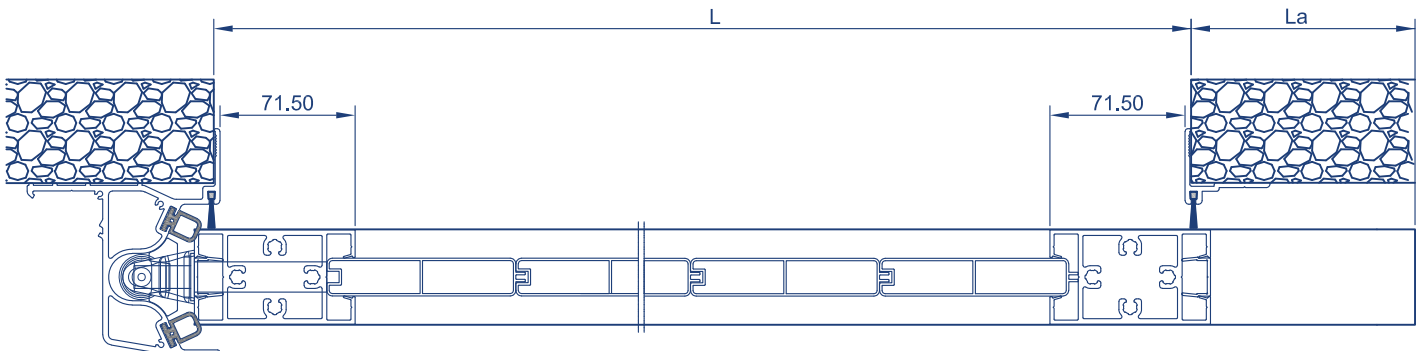

| | Ref. | Descrição | Horizontal | | | Vertical | | |
|--|--------|--------------------|------------|-----|--------|----------|---------------------|--------|
| | | | Corte | Qt. | Medida | Corte | Qt. | Medida |
| | A-9358 | Terminal de correr | | | | | 1 | H+15 |
| | A-9375 | Remate p/parede | | | | | 1 | H |
| | A-9360 | Folha lateral | | 1 | L+La+4 | | | |
| | A-9316 | Capa de remate | | 1 | L+La+4 | | 1 | H+15 |
| | A-9347 | Travessa | | | | | 2 | H-205 |
| | A-9369 | Perfil remate | | 1 | La | | 2 | H-205 |
| | A-9315 | Guia superior | | 1 | L+La-5 | | | |
| | A-9207 | Deslizador | | 1 | 2L+La | | | |
| | A-124 | Chapa dupla 100mm | | | | | $\frac{L-120}{100}$ | H-175 |

Cota "La" a definir pelo cliente

| Ref. | Descrição | Qt. |
|-------|------------------------------|-----|
| 34923 | Topo p/folha lateral | 4 |
| 34929 | Topo p/guia | 2 |
| 34901 | Calço união folha | 4 |
| 34953 | Fechadura 45mm | 1 |
| 34150 | Cilindro 70mm | 1 |
| 34955 | Ponto de fecho largo | 1 |
| 34956 | Ponto de fecho curto | |
| 34970 | Guia portão correr | 1 |
| 34985 | Suporte guia superior grande | 1 |
| 34981 | Rolamento de guia 33.5mm | 2 |
| 34991 | Rodízio nylon 80mm (Zincado) | 2 |
| 34992 | Rodízio nylon 80mm (Inox) | |
| 34972 | Batente | 1 |
| 34902 | Parafuso M8x50 | 16 |
| 34930 | Topo p/guia superior | 1 |

| Ref. | Descrição | Vertical | |
|-------|---------------------------|----------|--------|
| | | Qt. | Medida |
| 30716 | Pelúcia flexível 3.5x19mm | 2 | H |
| 31098 | Vedante de batente | 2 | H |

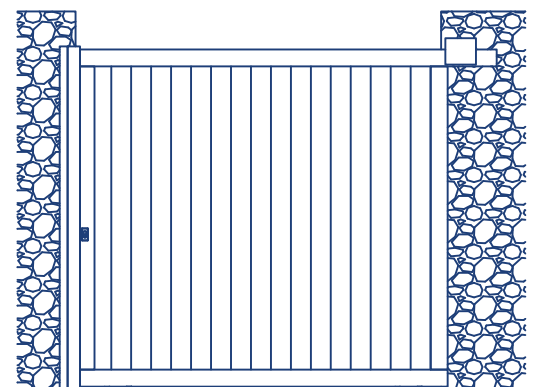



Portão de Correr C/Travessa (Aparafusar)

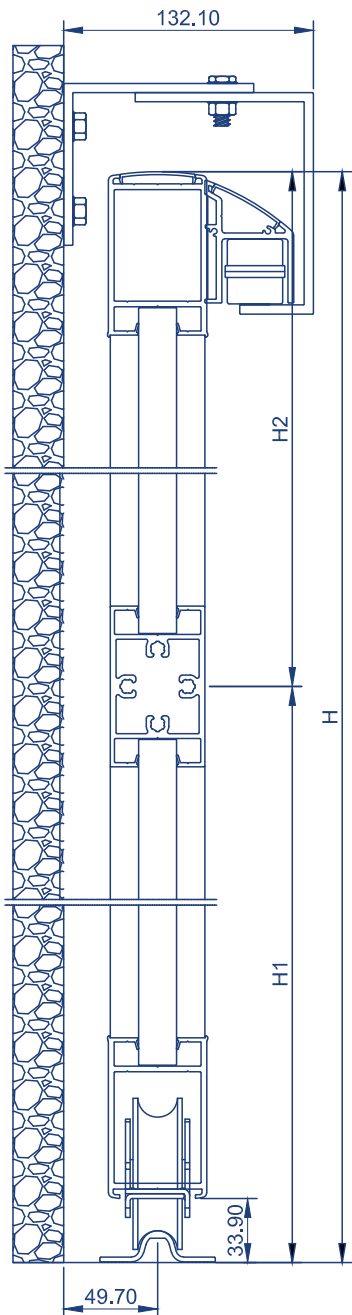
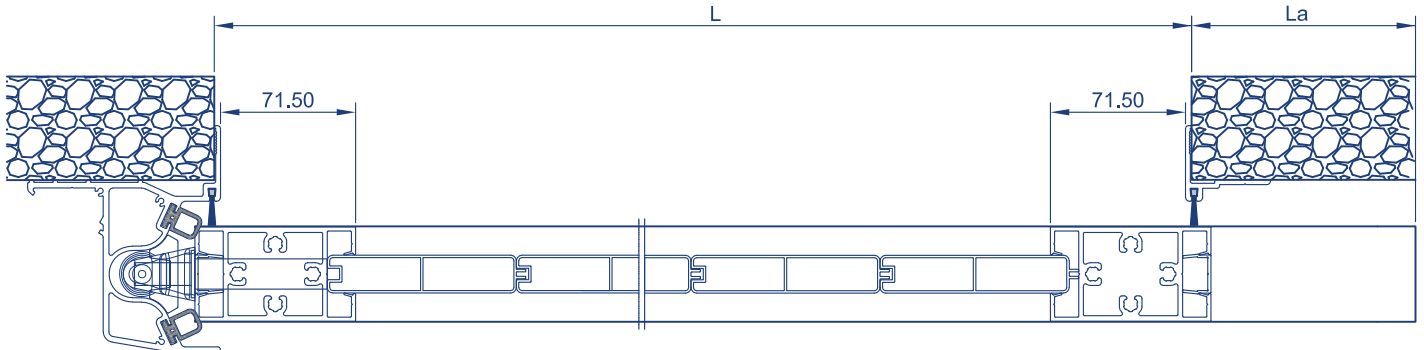

| | Ref. | Descrição | Horizontal | | | Vertical | | |
|--|--------|--------------------|------------|-----|--------|----------|--------------|--------|
| | | | Corte | Qt. | Medida | Corte | Qt. | Medida |
| | A-9358 | Terminal de correr | | | | | 1 | H+15 |
| | A-9375 | Remate p/parede | | | | | 1 | H |
| | A-9360 | Folha lateral | | 1 | L+La+4 | | | |
| | | | | 1 | L+8,5 | | | |
| | A-9316 | Capa de remate | | 1 | L+La+4 | | | H+15 |
| | | | | 1 | L+La-5 | | | |
| | A-9347 | Travessa | | 1 | L-150 | | 2 | H-205 |
| | A-9369 | Perfil remate | | 1 | La | | 2 | H-205 |
| | A-9315 | Guia superior | | 1 | L+La-5 | | | |
| | A-9207 | Deslizador | | 1 | 2L+La | | | |
| | A-124 | Chapa dupla 100mm | | | | | L-120 100 | H1-131 |
| | | | | | | | L-120 100 | H2-114 |

Cota "La" a definir pelo cliente

| Ref. | Descrição | Qt. |
|-------|------------------------------|-----|
| 34923 | Topo p/folha lateral | 4 |
| 34929 | Topo p/guia | 2 |
| 34901 | Calço união folha | 4 |
| 34970 | Guia portão correr | 1 |
| 34985 | Suporte guia superior grande | 1 |
| 34981 | Rolamento de guia 33.5mm | 2 |
| 34991 | Rodízio nylon 80mm (Zincado) | 2 |
| 34992 | Rodízio nylon 80mm (Inox) | |
| 34972 | Batente | 1 |
| 34902 | Parafuso M8x50 | 16 |
| 34930 | Topo p/guia superior | 1 |

| Ref. | Descrição | Vertical | |
|-------|---------------------------|----------|--------|
| | | Qt. | Medida |
| 30716 | Pelúcia flexível 3.5x19mm | 2 | H |
| 31098 | Vedante de batente | 2 | H |

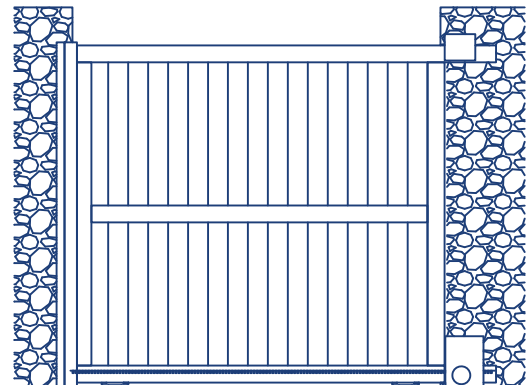

Vedação (Aparafusar)

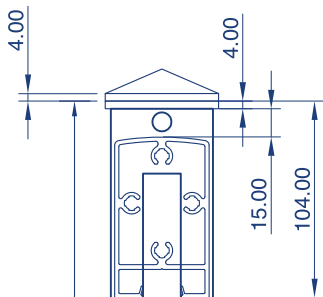
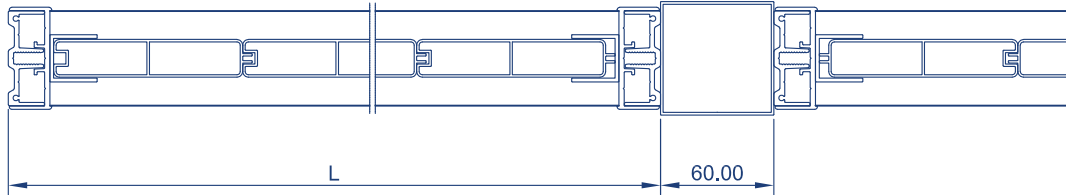

| | Ref. | Descrição | Horizontal | | | Vertical | | |
|--|--------|--------------------|------------|-----|--------|----------|--------------------|--------|
| | | | Corte | Qt. | Medida | Corte | Qt. | Medida |
| | A-9320 | Folha sup./inf. | | 1 | L-44 | | | |
| | A-9401 | Base p/vedação | | | | | 2 | H-26 |
| | A-9402 | Suporte p/vedação | | | | | 2 | H-20 |
| | A-9477 | Suporte lâminas | | | | | 2 | H-162 |
| | A-9403 | Travessa p/vedação | | 1 | L-44 | | | |
| | A-124 | Chapa dupla 100mm | | | | | $\frac{L-48}{100}$ | H-162 |
| | Tubo | Tubo 60x60 | | | | | N-1 | H-8 |

N - Número de divisões da vedação

| Ref. | Descrição | Qt. |
|-------|----------------|-----|
| 34927 | Topo regulável | 4N |
| 34931 | Topo 60x60 | N-1 |
| 34932 | Sapata 60x60 | N-1 |
| 34902 | Parafuso M8x50 | 12N |

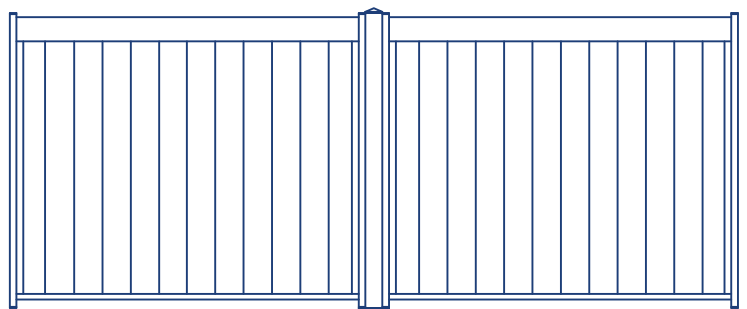
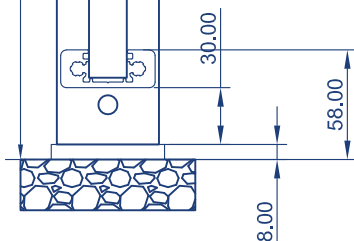

Vedação (Aparafusar)

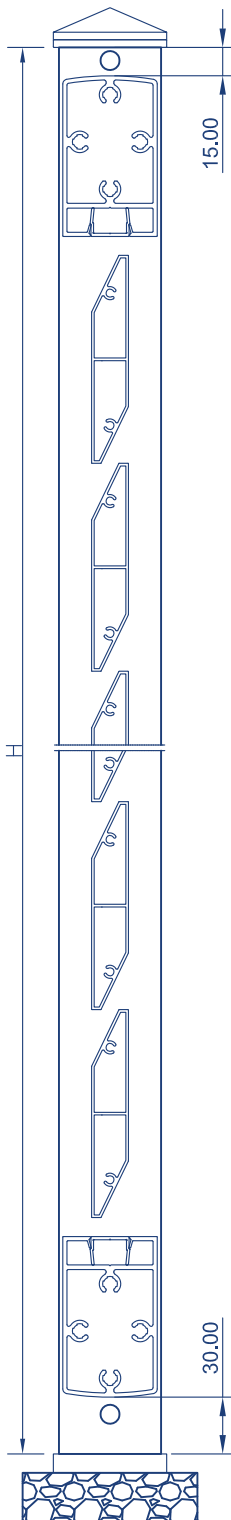
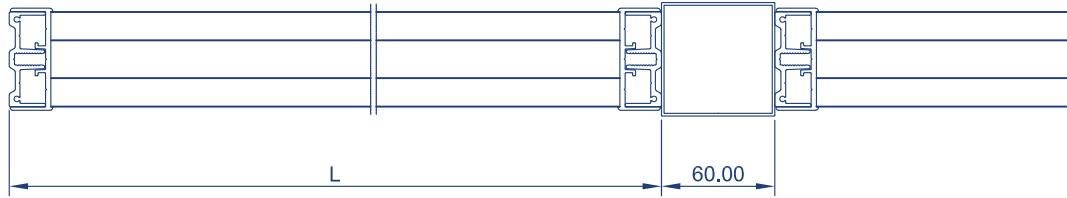

| | Ref. | Descrição | Horizontal | | | Vertical | | |
|--|--------|-------------------|------------|-----|--------|----------|---------------------|--------|
| | | | Corte | Qt. | Medida | Corte | Qt. | Medida |
| | A-9320 | Folha sup./inf. | | 2 | L-44 | | | |
| | A-9369 | Perfil de remate | | 2 | L-44 | | | |
| | A-9401 | Base p/vedação | | | | | 2 | H-26 |
| | A-9402 | Suporte p/vedação | | | | | 2 | H-20 |
| | A-9433 | Lâmina 110mm | | | | | $\frac{L-227}{110}$ | L-44 |
| | Tubo | Tubo 60x60 | | | | | N-1 | H-8 |

N - Número de divisões da vedação

| Ref. | Descrição | Qt. |
|-------|----------------|-----|
| 34927 | Topo regulável | 4N |
| 34931 | Topo 60x60 | N-1 |
| 34932 | Sapata 60x60 | N-1 |
| 34902 | Parafuso M8x50 | 16N |

